

J. STRAKA,
 FOUNTAIN PEN STAND.
 APPLICATION FILED OCT 25, 1920.

1,408,545.

Patented Mar. 7, 1922.

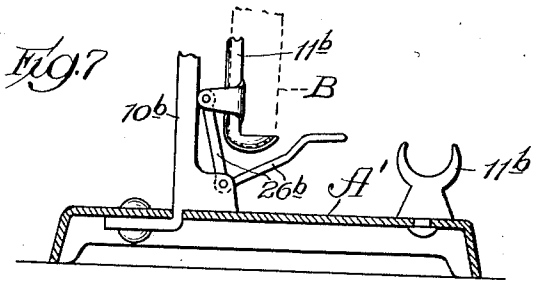
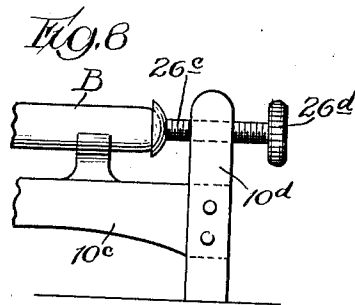
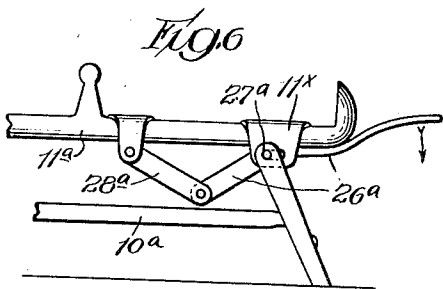
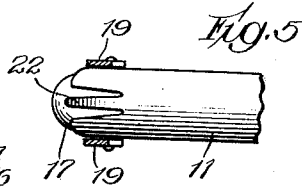
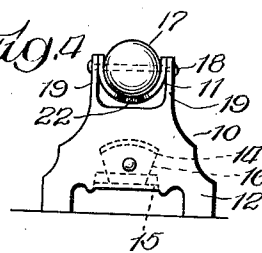
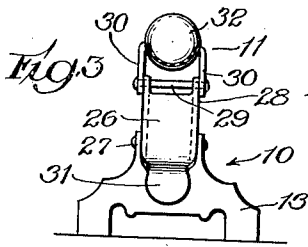
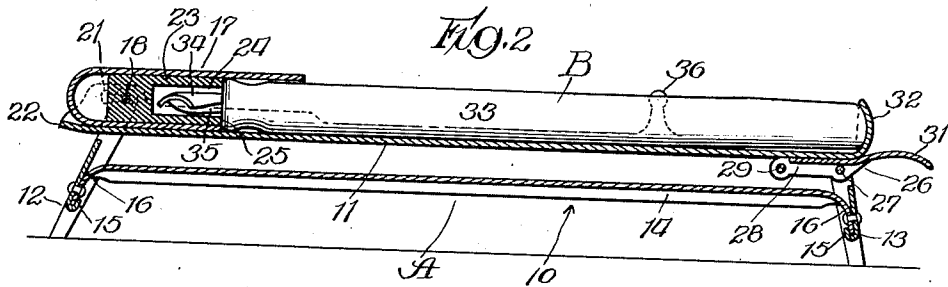
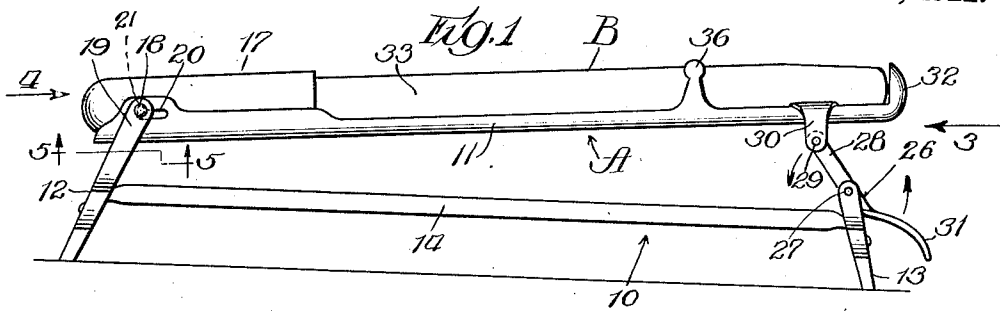

Inventor
 John Straka,
 By Charles O. Sherwin
 Atty.

UNITED STATES PATENT OFFICE.

JOHN STRAKA, OF CHICAGO, ILLINOIS, ASSIGNOR OF ONE-HALF TO JOSEPH R. LEWIS, OF CHICAGO, ILLINOIS.

FOUNTAIN-PEN STAND.

1,408,545.

Specification of Letters Patent.

Patented Mar. 7, 1922.

Application filed October 25, 1920. Serial No. 419,293.

To all whom it may concern:

Be it known that I, JOHN STRAKA, a citizen of the present Government of Czechoslovakia, and a resident of Chicago, Cook County, and State of Illinois, have invented certain new and useful Improvements in Fountain-Pen Stands, of which the following is declared to be a full, clear, and exact description.

This invention relates to fountain pens, and it has reference more particularly to a stand or a holder for holding a fountain pen, and keeping the pen point enclosed when not in use, so as to prevent the evaporation of the writing fluid, that usually occurs when the pen points of fountain pens remain uncovered for any considerable length of time.

As is well known, fountain pens are provided with removable covers or caps, which are removed when the pens are used and replaced when not in use. Such pens are usually carried about in a pocket of one's clothing, and one of the principal objects of the present invention is to provide a stand or holder for fountain pens, having as a part thereof, a closure, cover or cap for the pen, and which comprises an article adapted to act as an accessory to the writing desk, library table or the like and which is not liable to be carried away by the user as is the ordinary fountain pen, but may remain in its accustomed place.

Another object is to provide a stand or holder for fountain pens with means for effectively corking or enclosing the pen point and ink duct, when the pen is not in use, to thereby prevent evaporation of the writing fluid.

Another object is to provide a stand or holder for fountain pens arranged to hold the pen in a horizontal position, whereby the ink duct and the pen will therefore always be in condition for immediate use.

Another object is to provide a stand and closure that may be operated by one hand to enclose the pen point or release the pen from the closure.

Another object is to provide a fountain pen handle of convenient length without the necessity of attaching the usual cover to the handle to accomplish this end.

With these objects in view, this invention consists in a stand or pen holder having

means for holding a fountain pen, and means for enclosing the pen point and sealing it and the ink duct against the outer atmosphere. It further consists in a stand or pen holder having pen point enclosing means and means for forcibly holding the pen structure in sealing contact with the pen enclosing means. It further consists in a stand or pen holder arranged to enclose and seal the pen point and ink duct against the outer atmosphere, which can easily be manipulated by one hand in putting the pen in inclosed position and in disengaging it from the stand for use. It further consists in the several novel features hereinafter fully set forth and claimed.

The invention is clearly illustrated in the accompanying drawings, in which:—

Fig. 1 is a side elevation of a fountain pen stand and fountain pen, illustrating the preferred embodiment of the present invention, the parts being shown in released position; Fig. 2 is a central, vertical, longitudinal section thereof, showing the parts in closed position; Fig. 3 is an end view looking in the direction of the arrow 3 in Fig. 1; Fig. 4 is an end view, looking in the direction of the arrow 4 in Fig. 1; Fig. 5 is a detail, fragmental, horizontal section taken on line 5—5 of Fig. 1; Fig. 6 is a side elevation of a modification; Fig. 7 is a view partly in side elevation and partly in vertical section of a second modification and Fig. 8 is a side elevation of a third modification.

Referring to said drawing, and first to Figs. 1 to 5, inclusive, which illustrate the preferred embodiment of the present invention, the reference character A designates a stand or pen holder which conveniently may be formed of sheet metal, struck up into the desired shapes. Generally, said stand comprises a channel like or trough like pen support 11, supported at its ends upon a base comprising legs 12, 13, connected thereto as will be hereinafter set forth and a lengthwise extending brace member 14, which is riveted or otherwise secured to said legs and connects them and holds them in their spaced relation to each other. For convenience in manufacture, the lower edge portions of the legs may be formed into tongues 15, which are bent up to lie against the outer sides of down turned end portions 16 of the brace member 14.

At the end of the pen support 11, to which the leg 12 is attached, is the pen closure 17 for enclosing the pen point and sealing the ink duct of the fountain pen B, and said closure is connected to said pen support 11, although as a preference it has a slight amount of movement lengthwise thereof. As shown, the connection between the leg 12, pen support 11, and closure 17 comprises a pin 18 which passes through holes in upwardly extending ears or lugs 19, of the leg 12, through lengthwise extending slots 20 in the sides of the pen support 11 and through holes in the wall of the closure 17. At one end of the slots 20 are upwardly extending notches 21 that receive the pin 18 whenever it reaches that end of the slots, and the bottom of the pen support is slitted to leave a tongue 22 (see Fig. 5) that is bent upward to provide spring pressure against the underside of the closure 17, and thereby force the pin 18 into the notches 21. The closure 17 contains a recessed cap 23 of hard rubber or other suitable material, which may be secured thereto by the pin 18, or otherwise. The recess 24 of the cap is adapted to receive the pen point of the fountain pen and its edge 25 is arranged to engage the edge of the fountain pen handle around the pen point and ink duct.

At the end of the pen support opposite the closure the stand or holder is provided with means for forcibly holding the pen point end of the fountain pen in frictional contact with the cap 23 and sealing the joint between the cap and pen against the entrance of air. In the preferred form said means comprises a lever 26 pivotally secured between its ends, to the leg 13, as by a pivot pin 27, which extends transversely of the stand. One arm 28 of the lever 26 is pivotally connected to the pen support by a pin 29 which extends through the arm 28 of the lever 26 and through lugs 30 that project down from the pen support and may be formed as parts thereof. The other arm 31 of the lever 26 is bent up to form a finger or thumb piece whereby the lever is operated, and the parts are so constructed and proportioned that when in locked or operative position, the pivotal connection 29 between the lever and pen support occupies a position slightly past an imaginary straight line drawn from the pin 18 to the pivot pin 27 of the lever. The upper face of the lever 26 then acts as a stop or rest against which the pen support strikes and by which the adjacent end of the pen support is supported. Said end is formed with an upwardly projecting end portion 32, which abuts or bears against the end of the pen structure B.

The fountain pen mechanism may be constructed in accordance with any of the common and well known types, containing a res-

ervoir for ink in its handle 33, which supplies the pen point 34 with ink. As usual, an ink duct 35 underlies the pen point and feeds the ink from the reservoir to the pen point. Preferably the handle is made longer than that of the ordinary fountain pen, so as to be of convenient length without the usual cover with which fountain pens are equipped.

The pen support may be made quite shallow, if desired, and at suitable places the side walls thereof may be extended upward as at 36 and bent inwardly slightly to form spring clip-like holders for the pen.

In use the fountain pen is held between the cap 23 and end portion 32 of the pen support, as seen in Fig. 2. In this position the exposed parts of the pen point and ink duct are contained in the cap 23 and the latter and adjacent end of the handle 33 are held in firm pressing contact by the lever 26, and the air is thereby excluded from the pen and ink duct. To remove and use the fountain pen, the thumb or finger piece 31 of the lever 26 is pressed down, thereby swinging the arm 28 of the lever upward and moving the pen support in an upward and lengthwise direction of and away from the cover. When the notched ends 21 of the slots 20 reach the pin 18 the tongue 22 forces the pin 18 into the notches 21 and holds the pen support in the extended inclined position (see Fig. 1) assumed when the lever 26 is moved down as described. The handle 33 of the pen B is thereby released from the end part 32 and may be readily detached from the stand and used in the ordinary manner. To replace and cover its pen point, the pen point is inserted into the cap of the closure or enclosing member and the handle laid on the pen support with its outer end in front of the projecting end part 32 of the pen support. The thumb or finger piece of the lever 26 is then raised, which may be done by placing the thumb on the pen handle and a finger under the finger piece, pressing down on the pen handle and up on the finger piece, until the pivot pin 29 passes an imaginary straight line extending between the pins 18, 27. This movement of the arm 28 of the lever 26 causes the pen support, together with its upwardly projecting end part 32 to move toward the pen enclosing member 17, and the end part 32 encounters the adjacent end of the pen handle 33 and moves it in the direction of the pen enclosing member 18, bringing the edge or end of the handle at the pen point end into firm pressing engagement with the edge or end 25 of the cap 23 and tightly sealing the joint therebetween, and excluding air from the pen point and ink duct. Before the parts reach their locked position, the handle 33 engages the cap 23 and during the re-

mainder of the endwise movement of the pen support and pen, pressure is exerted against the pin 18 and against the pivot pin 27 of the lever 26 and the upper ends of the legs 12, 13, are thereby slightly spread apart, so that when the pin 29 passes said imaginary straight line extending between the pins 18, 27, and the pen support strikes the upper face of the lever 26, the parts are locked in such position against accidental disconnection.

In the modified form of the invention illustrated in Fig. 6, the base 10^a and closure are constructed substantially similar to that of the preferred form. The lever 26^a, however, in place of being directly connected to the pen support 11^a, is connected thereto by a link 28^a, the ends of the link being pivotally connected to the lever and pen support respectively, and with the lever 26^a forming a toggle lever-like arrangement. The pen support 11^a has lengthwise slotted lugs 11^x through which the pivot pin 27^a extends and supports the pen support. In this case the lever is pressed down to effect the closure of the pen, and is raised to release the pen.

In the modified form illustrated in Fig. 7, the base 10^b, pen support 11^b and closure are arranged in upright position and are mounted on a base plate A¹, and the lever 26^b is bent as shown for making it convenient to operate. In other respects this modified form may be constructed substantially similar to the preferred form. This form may be preferred by some to the other forms heretofore described, because the fountain pen is held in upright position with the pen pointing upward. This arrangement keeps the ink in the bottom portion of the reservoir. The base plate also provides a place for attaching a separate holder 11^b on which the pen may be laid temporarily.

In the modified form illustrated in Fig. 8, a heavier and more rigid base 10^c is shown. The closure may be secured to it in any suitable manner, and in place of the lever device for effecting the closure of the pen, a screw 26^c, threaded in a lug 10^d of the base is substituted. The screw has a head 26^a by which it may be readily turned in one direction to force the fountain pen into the closure, and in the other direction to release it.

Other alterations and modifications of the invention are possible without departing from the spirit of this invention; I desire, therefore, not to limit myself to the exact form of the construction shown and described, but intend, in the following claims, to point out all of the invention disclosed herein.

I claim as new and desire to secure by Letters Patent:

1. A fountain pen stand, comprising a

base, a closure secured thereto at one end and adapted to receive and close the pen point end of a fountain pen, and means on said base for holding said end of the pen in frictional contact with said closure. 70

2. A fountain pen stand, comprising a base having a pen support adapted to receive a fountain pen, a closure secured thereto at one end thereof for receiving the pen point end of the fountain pen, and means at the other end of said base for holding said end of the fountain pen in the closure. 75

3. A fountain pen stand, comprising a base, a closure secured thereto at one end and adapted to receive and close the pen point end of a fountain pen, a member on said base arranged to engage the handle end of the pen, and a lever fulcrumed on said base and connected with said handle engaging member, whereby said pen point end of said pen is moved in and held in frictional contact with said closure. 80 85

4. A fountain pen stand, comprising a base, a closure secured thereto at one end and adapted to receive and close the pen point end of a fountain pen, a fountain pen supporting member slidably connected to said base at the end having the closure, and having a projection at the other end arranged to engage the outer end of the fountain pen handle, and a lever fulcrumed on said base and directly connected with said pen supporting member, whereby said pen supporting member is moved lengthwise and therewith the pen is moved in and held in frictional contact with said closure. 90 95 100

5. A fountain pen stand, comprising a base, a closure secured thereto at one end and adapted to receive and close the pen point end of a fountain pen, a fountain pen supporting member slidably connected to said base at the end having the closure, and having a projection at the other end arranged to engage the outer end of the fountain pen handle, and a lever fulcrumed on said base below said pin supporting member and having an arm directly and pivotally connected thereto at a place below it, whereby the pivotal connection between the lever and pen supporting member may be moved down below an imaginary straight line extending between the point of connection of the pin supporting member and base and fulcrum of the lever to lock the parts in place, said lever acting as a stop to limit the downward movement of said arm. 105 110 115 120

6. A fountain pen stand comprising a base consisting of two legs and a lengthwise extending brace connecting them, a trough-like fountain pen supporting member having one end supported by and slidably connected with one of said legs, a fountain pen closure secured to said last mentioned leg, a fountain pen, the pen point end of which is insertible into said closure and adapted 125 130

- to be closed thereby, said pen supporting member having an upturned end arranged to engage the outer end of said fountain pen handle, and a lever fulcrumed on the other leg and connected to said pen supporting member and adapted to move said pen supporting member in a lengthwise direction and therewith move said pen into enclosed engagement with said closure.
7. A fountain pen stand, comprising a base, a fountain pen cover secured to one end thereof and having a cap therein for enclosing the pen point of a fountain pen and sealing it against air, and lever operated means supported by said base adapted to engage the outer end of the handle of said fountain pen to hold the handle in frictional engagement with said cap.
8. A fountain pen stand, comprising a base consisting of two legs and a lengthwise extending brace connected thereto, the upper ends of said legs being capable of spreading apart under force, and one leg having a pair of upwardly projecting ears, a trough-like fountain pen supporting member, formed at one end with an upturned tongue and with lengthwise extending slots terminating at one end in upwardly extending notches, a pin secured in the ears of said leg and extending through said slots, a fountain pen closure secured upon said pen, a fountain pen, the pen point of which is insertible into said closure, said pen supporting member having a part for engaging the outer end of the fountain pen, a lever fulcrumed on the other leg and having an arm pivotally connected to said pen supporting member and adapted to move said pen support in lengthwise directions, to close and release the pen from said closure, said notched end of the slots acting to receive the pin connection between the closure and legs when the pen support is retracted, and the tongue acting to yieldingly hold the pen support in such retracted position.

JOHN STRAKA.